

COOL ARC[®] 50

OPERATOR'S MANUAL



ENGLISH

LINCOLN[®]
ELECTRIC

THE WELDING EXPERTS[®]

Lincoln Electric Bester Sp. z o.o.
ul. Jana III Sobieskiego 19A, 58-263 Bielawa, Poland
www.lincolnelectric.eu

Declaration of conformity



Lincoln Electric Bester Sp. z o.o.

Declares that the welding machine:

K14050-1 COOL ARC[®] 50

conforms to the following directives:

2006/95/CEE, 2004/108/CEE

and has been designed in compliance with the
following standards:

EN 60974-2, EN 60974-10:2007

06.07.2010

Paweł Lipiński
Operations Director

Lincoln Electric Bester Sp. z o.o., ul. Jana III Sobieskiego 19A, 58-263 Bielawa, Poland

12/05



THE WELDING EXPERTS®

12/05

THANKS! For having chosen the **QUALITY** of the Lincoln Electric products.

- Please Examine Package and Equipment for Damage. Claims for material damaged in shipment must be notified immediately to the dealer.
- For future reference record in the table below your equipment identification information. Model Name, Code & Serial Number can be found on the machine rating plate.

| | |
|------------------------|-------|
| Model Name: | |
| | |
| Code & Serial Number: | |
| | |
| Date & Where Purchased | |
| | |











ENGLISH INDEX



| | |
|--|---|
| Safety | 1 |
| Introduction | 2 |
| Installation and Operator Instructions | 2 |
| Electromagnetic Compatibility (EMC) | 7 |
| Technical Specifications | 8 |
| WEEE | 8 |
| Spare Parts | 8 |
| Electrical Schematic | 9 |
| Accessories | 9 |



WARNING

This equipment must be used by qualified personnel. Be sure that all installation, operation, maintenance and repair procedures are performed only by qualified person. Read and understand this manual before operating this equipment. Failure to follow the instructions in this manual could cause serious personal injury, loss of life, or damage to this equipment. Read and understand the following explanations of the warning symbols. Lincoln Electric is not responsible for damages caused by improper installation, improper care or abnormal operation.

| | |
|---|---|
|  | <p>WARNING: This symbol indicates that instructions must be followed to avoid serious personal injury, loss of life, or damage to this equipment. Protect yourself and others from possible serious injury or death.</p> |
|  | <p>READ AND UNDERSTAND INSTRUCTIONS: Read and understand this manual before operating this equipment. Arc welding can be hazardous. Failure to follow the instructions in this manual could cause serious personal injury, loss of life, or damage to this equipment.</p> |
|  | <p>ELECTRIC SHOCK CAN KILL: Welding equipment generates high voltages. Do not touch the electrode, work clamp, or connected work pieces when this equipment is on. Insulate yourself from the electrode, work clamp and connected work pieces.</p> |
|  | <p>ELECTRICALLY POWERED EQUIPMENT: Turn off input power using the disconnect switch at the fuse box before working on this equipment. Ground this equipment in accordance with local electrical regulations.</p> |
|  | <p>ELECTRICALLY POWERED EQUIPMENT: Regularly inspect the input, electrode, and work clamp cables. If any insulation damage exists replace the cable immediately. Do not place the electrode holder directly on the welding table or any other surface in contact with the work clamp to avoid the risk of accidental arc ignition.</p> |
|  | <p>ELECTRIC AND MAGNETIC FIELDS MAY BE DANGEROUS: Electric current flowing through any conductor creates electric and magnetic fields (EMF). EMF fields may interfere with some pacemakers and welders having a pacemaker shall consult their physician before operating this equipment.</p> |
|  | <p>CE COMPLIANCE: This equipment complies with the European Community Directives.</p> |
|  | <p>ARTIFICIAL OPTICAL RADIATION: According with the requirements in 2006/25/EC Directive and EN 12198 Standard, the equipment is a category 2. It makes mandatory the adoption of Personal Protective Equipment (PPE) having filter with a protection degree up to a maximum of 15, as required by EN169 Standard.</p> |
|  | <p>FUMES AND GASES CAN BE DANGEROUS: Welding may produce fumes and gases hazardous to health. Avoid breathing these fumes and gases. To avoid these dangers the operator must use enough ventilation or exhaust to keep fumes and gases away from the breathing zone.</p> |
|  | <p>ARC RAYS CAN BURN: Use a shield with the proper filter and cover plates to protect your eyes from sparks and the rays of the arc when welding or observing. Use suitable clothing made from durable flame-resistant material to protect you skin and that of your helpers. Protect other nearby personnel with suitable, non-flammable screening and warn them not to watch the arc nor expose themselves to the arc.</p> |
|  | <p>WELDING SPARKS CAN CAUSE FIRE OR EXPLOSION: Remove fire hazards from the welding area and have a fire extinguisher readily available. Welding sparks and hot materials from the welding process can easily go through small cracks and openings to adjacent areas. Do not weld on any tanks, drums, containers, or material until the proper steps have been taken to insure that no flammable or toxic vapors will be present. Never operate this equipment when flammable gases, vapors or liquid combustibles are present.</p> |

| | |
|---|---|
|  | <p>WELDED MATERIALS CAN BURN: Welding generates a large amount of heat. Hot surfaces and materials in work area can cause serious burns. Use gloves and pliers when touching or moving materials in the work area.</p> |
|  | <p>CYLINDER MAY EXPLODE IF DAMAGED: Use only compressed gas cylinders containing the correct shielding gas for the process used and properly operating regulators designed for the gas and pressure used. Always keep cylinders in an upright position securely chained to a fixed support. Do not move or transport gas cylinders with the protection cap removed. Do not allow the electrode, electrode holder, work clamp or any other electrically live part to touch a gas cylinder. Gas cylinders must be located away from areas where they may be subjected to physical damage or the welding process including sparks and heat sources.</p> |
|  | <p>SAFETY MARK: This equipment is suitable for supplying power for welding operations carried out in an environment with increased hazard of electric shock.</p> |

The manufacturer reserves the right to make changes and/or improvements in design without upgrade at the same time the operator's manual.

Introduction

The **COOL ARC® 50** is a cooling system designed for use with water-cooler torches and guns:

- GTAW torches
- MGAW guns up to 500A.

The following equipment has been added to **COOL ARC® 50**:

- Hose with quick water connector – 0,2m.

COOL ARC® 50 is delivered empty with no coolant in the system.

Recommended equipment, which can be bought by user, was mentioned in the chapter "Accessories".

Installation and Operator Instructions

Read this entire section before installation or operation of the machine.

Location and Environment

This machine will operate in harsh environments. However, it is important that simple preventative measures are followed to assure long life and reliable operation:

- Do not place or operate this machine on a surface with an incline greater than 15° from horizontal.
- Do not use this machine for pipe thawing.
- This machine must be located where there is free circulation of clean air without restrictions for air movement to and from the air vents. Do not cover the machine with paper, cloth or rags when switched on.
- Dirt and dust that can be drawn into the machine should be kept to a minimum.
- This machine has a protection rating of IP23. Keep it dry when possible and do not place it on wet ground or in puddles.
- Locate the machine away from radio controlled machinery. Normal operation may adversely affect the operation of nearby radio controlled machinery, which may result in injury or equipment damage. Read the section on electromagnetic compatibility in this manual.
- Do not operate in areas with an ambient temperature greater than 40°C.

Product Description

COOL ARC® 50 is the cooler for semi automatic welding with water cooled TIG, MIG.



COOL ARC® 50 cooler is designed for use with all water-cooled gun's up to 500A, TIG and MIG torches and guns.

The **COOL ARC® 50** coolers bring new technology in the areas of pump, heat exchanger and reservoir designs to the water cooler market. These technologies allow the **COOL ARC® 50** coolers to be lighter in weight, lower in energy consumption.

Warranty

Warranty for this product is 3 year after the date of purchase. For any warranty claim, contact a certified Lincoln service center.

Installation

Coolant INLET and OUTLET fittings (A) type 21KATS09MPX are placed at the front of the unit. The blue fitting is marked  (supplies coolant to the welding equipment); the red ones is marked  (takes warm coolant from the welding equipment).

The FILL CAP of the coolant reservoir is on front of the unit (B). Fill Cap can be removed by twisting it off.

The coolant FLOW INDICATOR is accessed by removal of the reservoir fill cap. Actual return flow is directly visible by the fill opening (C).

Coolant volume can be monitored through translucent reservoir in the front (D). The minimum coolant level is indicated by the line "MINIMUM LIQUID LEVEL" on label.

Air flow louvers (E): Air flow louvers secure adequate air circulation. The side louvers allow sucking in cold air from bottom of the unit. Hot air is removed by the front louvers.

Voltage switch (F) serve to set voltage according supply power source 230/400 V.

For convenience you can press and hold the **FLOW SENSOR OFF** switch (G) and the torch button to fill the water system on first usage.

Cables length (H) are adjustable. In order to extend the cables unscrew the cable glands (I), pull out the cables, then tighten the cable glands (I).

! WARNING

INCORPORATED INTO THE COOLER IS AN AUTOMATIC FLOW SENSOR TO DETECT LOW OR NO COOLANT FLOW. A LOW OR NO FLOW CONDITION WILL CAUSE WELDING OUTPUT TO AUTOMATICALLY STOP TO PROTECT THE TORCH.

! WARNING

DO NOT SWITCH VOLTAGE DURING POWER SOURCE IS ON.

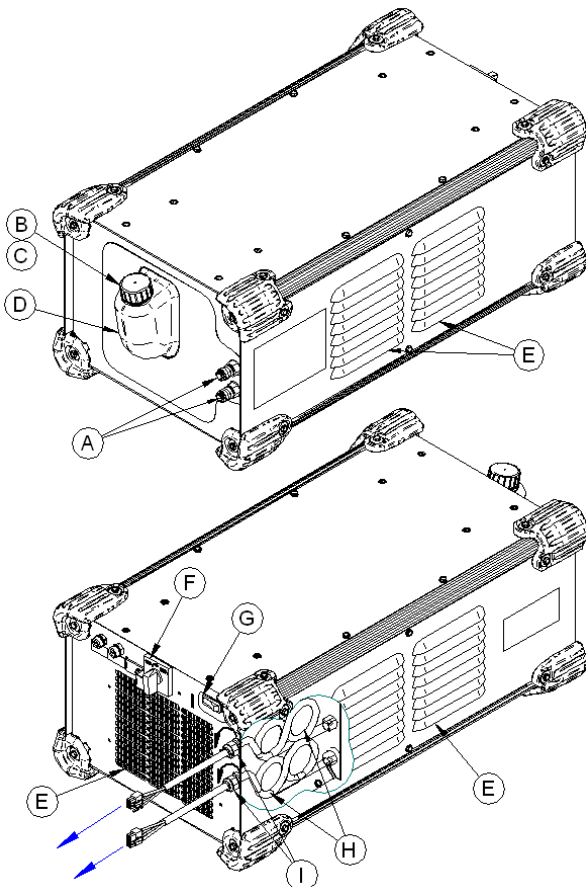

Figure 1

Filling The Reservoir

Proper Coolant Addition

Acorox is recommended coolant for COOL ARC® 50.

For use above freezing: Tap, distilled, deionized, mineral water. For use below freezing: water and pure ethylene glycol mixture (10% glycol between at 0°C and 30% at -15°C).

! WARNING

DO NOT USE PREPACKAGED WELDING INDUSTRY COOLANTS. These coolants may contain oil-based substances which attack the plastic components in the pump of the **COOL ARC® 50** cooler and severely reduce pump life. Once added to the cooler, the substances are virtually impossible to purge from the water lines and heat exchanger.

To avoid freeze damage and water leakage in shipment, every **COOL ARC® 50** unit is delivered empty with no coolant in the system. To fill the unit, locate the plastic reservoir fill cap (B).

NOTE: The unit can be filled only horizontal.

! WARNING

UNPLUG THE COOLER BEFORE FILLING THE RESERVOIR.

Filling:

Pour **6 liters at least** of coolant into the reservoir.

! WARNING

AVOID SPILLING COOLANT INTO THE FRONT CASING OF THE UNIT.

NOTE: DO NOT ADD MORE THAN 9 LITERS OF COOLANT INTO THE RESERVOIR.

! WARNING

AT FIRST STARTING OF THE **COOL ARC® 50** RESERVOIR FILL CAP MUST BE REMOVED FOR A MOMENT TO AVOID GENERATE PARTIAL VACUUM IN COOLING SYSTEM DURING FILLING (THE PUMP MUST BE FLOODING).

The fill cap contains a pressure release air hole.

Be certain to replace the reservoir fill cap when the reservoir is full. Operation of the **COOL ARC® 50** cooler without the fill cap in place can cause poor cooling efficiency, evaporation loss of coolant, and low product life.

Water Hoses Connection

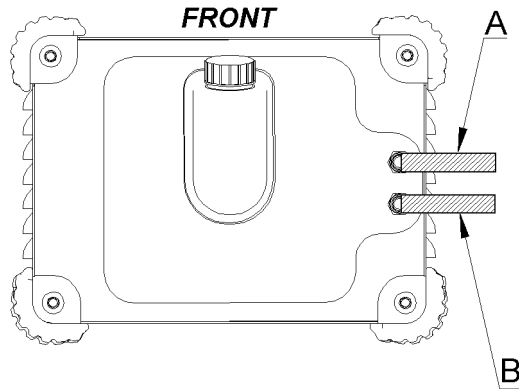

Figure 2
Water Hoses Connection Diagram

- A FROM HEAT SOURCE (RED)
B TO HEAT SOURCE (BLUE)

Water hoses connection is made with quick water fittings (type 21KATS09MPX) which are equipped with the automatic outflow blockade.

Before water hoses installing to the cooler, you should check if the water hose connectors matches to the quick water connectors placed in the connector block on the front of the unit. You should:

- Take INLET hose (colored or tagged blue on most hoses) and attach it into the coolant OUT line marked . Then take the OUTLET hose (colored or tagged red on most hoses) and attach it into the coolant IN line marked .

WARNING

BE CERTAIN THAT NO LEAKS EXIST WHEN COOLER IS TURNED ON. A LEAK WILL DEplete RESERVOIR VOLUME, CAUSE POOR OR COOLING PERFORMANCE AND REDUCE GUN, TORCH OR PUMP LIFE.

The following should always be observed when operating the **COOL ARC® 50**:

- Never operate the cooler with case off.
- Immersion in water around electrical lines can cause electrical shock.
- Never place fingers into openings of cooler. Moving parts can injure.
- Unplug the cooler before filling the reservoir.
- Never operate the cooler with the reservoir fill cap off.
- Never operate the cooler with the reservoir empty.

Operating Precautions

The following should always be observed when operating any **COOL ARC® 50** cooler:

- Check the reservoir daily.
- Keep the reservoir full especially after changing any water lines.
- Avoid placing the cooler near areas of extreme heat.
- Avoid placing the cooler near a flux hopper or an area where dust build-up is extreme.
- Avoid kinking or putting sharp bends in any water lines.
- Keep all water lines clean.

Turning The System ON

After filling the reservoir and connecting the coolant hoses to the **COOL ARC® 50** cooler per the Installation Sections, be certain that the power input into the unit matches the cooler's rated input. Set correct power supply using switch on the rear. Next plug the unit into an electrical receptacle for start-up operation.

You will be able to hear the fan running and feel air flow out of the back of the unit when the cooler is operating. When first starting the unit, check all of the water lines to insure that no water leaks are present. Water leakage causes poor welding performance, poor cooling performance, low welding component and pump life and potential electrical safety hazards.

Cooling Efficiency

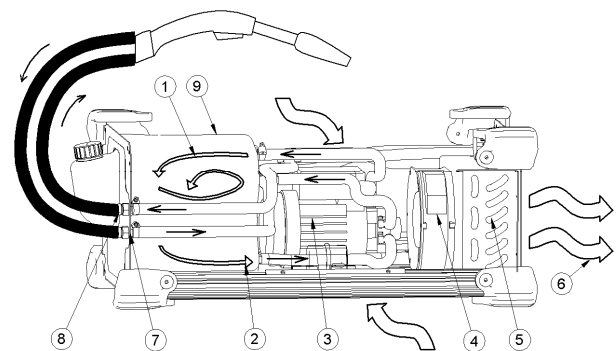

- COOLANT RETURN
- COOLANT IN TAKE
- PUMP
- FAN
- HEAT EXCHANGER
- HEATED AIR OUT
- COOLANT IN
- COOLANT OUT
- RESERVOIR

FIGURE 3
Circulation of COOL ARC® 50

The high cooling efficiency **COOL ARC® 50** offers a cooler, more comfortable weld than conventional air-cooled procedures as well as leading competitors water cooled systems. Radiator improves heat convection with minimal air flow restriction.

The **COOL ARC® 50** cooler effectively removes the heat of the arc away from the torch handle and places it into the exiting air flow at the back of the cooler. Ambient air temperature can affect the cooling parameters of the **COOL ARC® 50**.

For example:

- COOL day (50°F, 10°C):** More HEAT is transferred from the water in the heat exchanger to the air. The water is COOLER and more HEAT is transferred from the torch to the water.

RESULT: THE TORCH FEELS COOLER

- HOT day (100°F, 38°C):** Less HEAT is transferred from the water in the heat exchanger to the air. The water is HOTTER and less HEAT is transferred from the torch to the water.

RESULT: THE TORCH FEELS HOTTER.

Unlike other water coolers that depend on bulky reservoir size, the high efficiency components of **COOL ARC® 50** cooler allows the reservoir size to be small. The result is a lightweight, portable unit.

Cooling Efficiency - Recommended Values

| COOL ARC® 50 ref: K14050-1 | |
|---|------|
| Max welding current TIG 100% duty cycle | 500A |
| Max welding current MIG 100% duty cycle | 500A |

Transport

To avoid freeze damage and water leakage during transport, the coolant has to be removed from the cooler's reservoir.

Maintenance

WARNING

For any repair operations, modifications or maintenances, it is recommended to contact the nearest Technical Service Center or Lincoln Electric. Repairs and modifications performed by unauthorized service or personnel will cause, that the manufacturer's warranty will become null and void.

Any noticeable damage should be reported immediately and repaired.

Routine maintenance (everyday)

- Check condition of water-cooler hoses, connections of the power lead.
- Check the welding torch / gun condition: replace it, if necessary.
- Check condition and operation of the cooling fan. Keep clean its airflow slots.
- The reservoir volume should be checked daily before using the cooler!!
- Keep the reservoir full, especially after disconnecting the water lines or changing the accessory being cooled.

Periodic maintenance (not less than once a year)

Perform the routine maintenance and, in addition:

- Keep the machine clean. Using a dry (and low pressure) airflow, remove the dust from the external case and from the cabinet inside.
- In dirty or dusty environments or if biological growth occurs in the coolant, it may be necessary to flush the coolant reservoir. Drain the old coolant, rinse the inside of the reservoir and circulate rinsing solution through the coolant system. Add new coolant when cleaning is finished.

WARNING

Hot coolant can burn skin. Always be sure coolant is **NOT HOT** before servicing the cooler.

WARNING



Special precautions have to be taken when the coolant is removed from the cooler reservoir. The coolant must not be poured out into ground water, sewerage, soil. Read "Material Safety Data Sheet" (coolant used) and contact the local Department of Environmental Protection office to obtain information on recycling coolant.

The frequency of the maintenance operations may vary in accordance with the working environment where the machine is placed.

WARNING

Do not touch electrically live parts.

WARNING

Before the case of machine will be removed, the machine had to be turned off and the power lead had to be disconnected from mains socket.

WARNING

Mains supply network must be disconnected from the machine before each maintenance and service. After each repair, perform proper tests to ensure safety.

Troubleshooting

This Troubleshooting Guide is designed to be used by the machine Owner/Operator. Unauthorized repairs performed on this equipment may result in danger to the technician and machine operator and will invalidate your factory warranty. For your safety, please observe all safety notes and precautions detailed in the Safety Section of this manual to avoid electrical shock or danger while troubleshooting this equipment.

WARNING

If for any reason you do not understand the test procedures or are unable to perform the tests/repairs safely, contact your local Authorized Field Service Facility for technical troubleshooting assistance before you proceed.

| | | |
|---|--|--|
| Cooler stops after few seconds. | <ul style="list-style-type: none"> The Flow Sensor took effect. Water system has not yet been filled (especially for long interconnection cables). | <ul style="list-style-type: none"> Repair leak. Fill the entire water system (interconnection cable, feeder, torch) by pressing and holding the torch button and "Flow Sensor OFF" button. |
| Cooler does not operate. | <ul style="list-style-type: none"> Blown fuses. Cord unplugged. No power at outlet. Cordset damaged. Water lines blocked or crimped. Leak in gun or water hoses. Reservoir empty. | <ul style="list-style-type: none"> Replace fuses. Plug in cord. Check outlet circuit breaker. Repair damaged cord or order new cordset. Clear blockage in hose. Avoid kinking or putting sharp bends in water lines. Repair leak. Fill reservoir. |
| Internal water leak. | <ul style="list-style-type: none"> Hose clamp loose on one of internal hoses. Internal hose punctured. Heat exchanger leaking. | <ul style="list-style-type: none"> Tighten or replace hose clamp. Replace punctured hose with new hose. Replace heat exchanger. |
| Leak at inlet/outlet connector block. | <ul style="list-style-type: none"> Hose clamp loose. | <ul style="list-style-type: none"> Tighten hose clamp onto hose. |
| Torch runs hot. | <ul style="list-style-type: none"> Unit placed by area of extreme heat. Low coolant flow. No coolant flow. Fan not operating. | <ul style="list-style-type: none"> Move unit away from hot air. See Low Coolant Flow Section. See No Coolant Flow Section. Reference fan section. |
| Fan operates but there is low coolant flow. | <ul style="list-style-type: none"> Leak in torch/gun or hoses. Torch/gun or hoses partially obstructed. Reservoir empty or very low. | <ul style="list-style-type: none"> Repair leak. Clear obstruction. Refill reservoir. |
| Fan operates but there is no coolant flow. | <ul style="list-style-type: none"> Pump failure. Pump seized. | <ul style="list-style-type: none"> Replace pump. Replace pump. |
| Pump operates, but fan does not. | <ul style="list-style-type: none"> Fan blade contacting heat exchanger. Fan motor failure. | <ul style="list-style-type: none"> Replace fan. Replace fan. |
| Cooler trips outlet circuit breaker. | <ul style="list-style-type: none"> Circuit overloaded. Cooler electrical component failure. | <ul style="list-style-type: none"> Check outlet circuit breaker. Replace component inside of cooler. |

Electromagnetic Compatibility (EMC)

11/04

This machine has been designed in accordance with all relevant directives and standards. However, it may still generate electromagnetic disturbances that can affect other systems like telecommunications (telephone, radio, and television) or other safety systems. These disturbances can cause safety problems in the affected systems. Read and understand this section to eliminate or reduce the amount of electromagnetic disturbance generated by this machine.



This machine has been designed to operate in an industrial area. To operate in a domestic area it is necessary to observe particular precautions to eliminate possible electromagnetic disturbances. The operator must install and operate this equipment as described in this manual. If any electromagnetic disturbances are detected the operator must put in place corrective actions to eliminate these disturbances with, if necessary, assistance from Lincoln Electric.

Before installing the machine, the operator must check the work area for any devices that may malfunction because of electromagnetic disturbances. Consider the following.

- Input and output cables, control cables, and telephone cables that are in or adjacent to the work area and the machine.
- Radio and/or television transmitters and receivers. Computers or computer controlled equipment.
- Safety and control equipment for industrial processes. Equipment for calibration and measurement.
- Personal medical devices like pacemakers and hearing aids.
- Check the electromagnetic immunity for equipment operating in or near the work area. The operator must be sure that all equipment in the area is compatible. This may require additional protection measures.
- The dimensions of the work area to consider will depend on the construction of the area and other activities that are taking place.

Consider the following guidelines to reduce electromagnetic emissions from the machine.

- Connect the machine to the input supply according to this manual. If disturbances occur it may be necessary to take additional precautions such as filtering the input supply.
- The output cables should be kept as short as possible and should be positioned together. If possible connect the work piece to ground in order to reduce the electromagnetic emissions. The operator must check that connecting the work piece to ground does not cause problems or unsafe operating conditions for personnel and equipment.
- Shielding of cables in the work area can reduce electromagnetic emissions. This may be necessary for special applications.

WARNING

The Class A equipment is not intended for use in residential locations where the electrical power is provided by the public low-voltage supply system. There may be potential difficulties in ensuring electromagnetic compatibility in those locations, due to conducted as well as radiated disturbances.

Technical Specifications

| NAME | | INDEX | |
|--|---|---|-----------------|
| COOL ARC® 50 | | K14050-1 | |
| INPUT | | | |
| Input Voltage | Input Amperes I ₁ max | Frequency | EMC Class |
| 400/230 V ± 10% single phase | 1,2A | 50/60Hz | A |
| RATED OUTPUT AT 40°C | | | |
| Flow range MIG TIG Open flow | 0,5 to 3,3 l/min with torch 4,5m: 1,7 ÷ 1,8 l/min with torch 3,8m: 1,3 ÷ 1,4 l/min 3,3 l/min | | |
| PARAMETERS RATING | | | |
| The cooling power of flow 1liter per minute at temperature of 25°C | | Maximum pressure rate | |
| 1,15 kW | | 0,4 MPa | |
| PARAMETERS OF THE COOLER'S RESERVOIR | | | |
| Maximum reservoir capacity | | Minimum required reservoir capacity | |
| 9,2 l | | 6 l | |
| COOLANT | | | |
| Recommended coolant | Acorox | | |
| Do not use!! | Pre-packaged welding industry coolants. These coolants may contain oil-based substances, which attack the plastic components of the cooler. Once added to the cooler, these substances are impossible to purge from the water lines and heat exchanger. | | |
| | Automotive anti-freeze. These coolants will damage the pump and block of the heat exchanger, affecting cooling performance. | | |
| PHYSICAL DIMENSIONS | | | |
| Height 265 mm | Width 355 mm | Length 680 mm | Weight 21 kg |
| Protection Rating IP23 | Operating Temperature -10°C (14°F) to +40°C (104°F) | Storage Temperature -25°C (-13°F) to +55°C (131°F) | |

WEEE

| | | |
|--|--|-------|
|  English | <p>Do not dispose of electrical equipment together with normal waste!</p> <p>In observance of European Directive 2002/96/EC on Waste Electrical and Electronic Equipment (WEEE) and its implementation in accordance with national law, electrical equipment that has reached the end of its life must be collected separately and returned to an environmentally compatible recycling facility. As the owner of the equipment, you should get information on approved collection systems from our local representative.</p> <p>By applying this European Directive you will protect the environment and human health!</p> | 07/06 |
|--|--|-------|

Spare Parts

| | |
|--|-------|
| <p>Part List reading instructions</p> <ul style="list-style-type: none"> Do not use this part list for a machine if its code number is not listed. Contact the Lincoln Electric Service Department for any code number not listed. Use the illustration of assembly page and the table below to determine where the part is located for your particular code machine. Use only the parts marked "•" in the column under the heading number called for in the assembly page (# indicate a change in this printing). | 12/05 |
|--|-------|

First, read the Part List reading instructions above, then refer to the "Spare Part" manual supplied with the machine, that contains a picture-descriptive part number cross-reference.

Electrical Schematic

Refer to the "Spare Part" manual supplied with the machine.

Accessories

| | | |
|---|----------|-----------------------|
|  | K10420-1 | Coolant Acorox (2x5l) |
|---|----------|-----------------------|